

# Panasonic®

## Operating Instructions

LCD Projector

Model No. **PT-AE4000U**

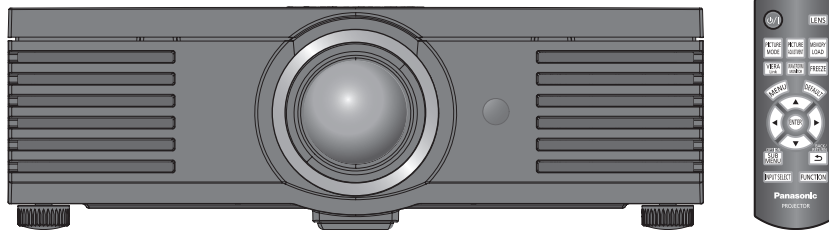

**HDMI™**  
HIGH-DEFINITION MULTIMEDIA INTERFACE



Thank you for purchasing this Panasonic product.  
Before operating this product, please read the instructions carefully, and save this manual for future use.  
Please read the functional instructions that is in the provided CD-ROM for more details.

TQBJ0309

**ENGLISH**

# Important Safety Notice

## Dear Panasonic Customer:

The following information should be read and understood as it provides details, which will enable you to operate the projector in a manner which is both safe to you and your environment, and conforms to legal requirements regarding the use of projectors. Before connecting, operating or adjusting this projector, please read these instructions completely and save this booklet with the projector for future reference. We hope it will help you to get the most out of your new product, and that you will be pleased with your Panasonic LCD projector.

The serial number of your product may be found on its bottom. You should note it in the space provided below and retain this booklet in case service is required.

Model number: **PT-AE4000U**

Serial number:

**WARNING:** TO REDUCE THE RISK OF FIRE OR ELECTRIC SHOCK, DO NOT EXPOSE THIS PRODUCT TO RAIN OR MOISTURE.

**Power Supply:** This LCD Projector is designed to operate on 100 V - 240 V, 50 Hz/60 Hz AC, house current only.

**CAUTION:** The AC power cord which is supplied with the projector as an accessory can only be used for power supplies up to 125 V, 7 A. If you need to use higher voltages or currents than this, you will need to obtain a separate 250 V power cord. If you use the accessory cord in such situations, fire may result.



The lightning flash with arrowhead symbol, within an equilateral triangle, is intended to alert the user to the presence of uninsulated "dangerous voltage" within the product's enclosure that may be of sufficient magnitude to constitute a risk of electric shock to persons.



The exclamation point within an equilateral triangle is intended to alert the user to the presence of important operating and maintenance (servicing) instructions in the literature accompanying the product.

**CAUTION:** This equipment is equipped with a three-pin grounding-type power plug. Do not remove the grounding pin on the power plug. This plug will only fit a grounding-type power outlet. This is a safety feature. If you are unable to insert the plug into the outlet, contact an electrician. Do not defeat the purpose of the grounding plug.

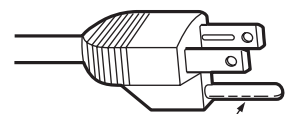

Do not remove

**NOTICE:** This product has a High Intensity Discharge (HID) lamp that contains mercury. Disposal may be regulated in your community due to environmental considerations. For disposal or recycling information, please contact your local authorities, or the Electronic Industries Alliance: <http://www.eiae.org>

**WARNING:**

This equipment has been tested and found to comply with the limits for a Class B digital device, pursuant to Part 15 of the FCC Rules. These limits are designed to provide reasonable protection against harmful interference in a residential installation. This equipment generates, uses and can radiate radio frequency energy and, if not installed and used in accordance with the instructions, may cause harmful interference to radio communications. However, there is no guarantee that interference will not occur in a particular installation. If this equipment does cause harmful interference to radio or television reception, which can be determined by turning the equipment off and on, the user is encouraged to try to correct the interference by one or more of the following measures:

- Reorient or relocate the receiving antenna.
- Increase the separation between the equipment and receiver.
- Connect the equipment into an outlet on a circuit different from that to which the receiver is connected.
- Consult the dealer or an experienced radio/TV technician for help.

**FCC CAUTION:** To assure continued compliance, use only shielded interface cables when connecting to computers or peripheral devices. Any unauthorized changes or modifications to this equipment will void the users authority to operate.

Pursuant to at the directive 2004/108/EC, article 9(2)  
 Pursuant to at the directive 2005/32/EC amended by 2008/28/EC, article 14  
 Panasonic Testing Center  
 Panasonic Service Europe, a division of Panasonic Marketing Europe GmbH  
 Winsbergring 15, 22525 Hamburg, F.R. Germany

**WARNING:** Not for use in a computer room as defined in the Standard for the Protection of Electronic Computer/Data Processing Equipment, ANSI/NFPA 75.

**Declaration of Conformity**

Model Number: PT-AE4000U  
 Trade Name: **Panasonic**  
 Responsible party: Panasonic Corporation of North America  
 Address: One Panasonic Way, Secaucus, New Jersey 07094  
 Telephone number: (888) 411 - 1996

This device complies with Part 15 of the FCC Rules. Operation is subject to the following two conditions: (1) This device may not cause harmful interference, and (2) this device must accept any interference received, including interference that may cause undesired operation.

**Information on Disposal in other Countries outside the European Union**



These symbols are only valid in the European Union.  
 If you wish to discard this product, please contact your local authorities or dealer and ask for the correct method of disposal.



**Environment care information for users in China**



This symbol is only valid in China.

**PT-AE4000U includes the following features and many more...**

### **Lens Memory**

Memorize focus/zoom position of the lens, for easy transition between different aspect contents (ex. 16:9 to 2.35:1).  
With auto switching capability.

### **Waveform Monitor**

Adjust the luminance level of the input signal to display full dynamic range of the content.

### **VIERA Link**

Control multiple Panasonic devices and other CEC compatible devices via HDMI cable using the projector remote.

### **Split Adjust Mode**

Perform adjustments to the image by viewing the before and after image side by side.

- Consult the Functional Instructions included in the CD-ROM for instructions on how to use these features.

## **Quick steps**

**1. Set up your projector**  
See "Setting up" on page 14.



**2. Connect with other devices**  
See "Connections" on page 15.



**3. Prepare the remote control**  
See "Remote control" on page 11.



**4. Start projecting**  
See "Switching the projector on/off" on page 16.



**5. Adjust the image**  
See "Menu Navigation" on page 19.

# Contents

## Important Information

<b>Important Safety Notice</b> .....	<b>2</b>
<b>Precautions with regard to safety</b> .....	<b>6</b>
WARNING .....	6
CAUTION .....	7
Cautions when transporting .....	8
Cautions when installing.....	8
Cautions on use .....	9
Cleaning and maintenance.....	9
Disposal.....	9
Accessories .....	10

## Preparation

<b>About Your Projector</b> .....	<b>11</b>
Remote control .....	11
Projector body .....	12

## Getting Started

<b>Setting up</b> .....	<b>14</b>
Screen size and throw distance .....	14
Projection method .....	14
Lens shift and positioning.....	15
<b>Connections</b> .....	<b>15</b>
Before connecting to the projector .....	15

## Basic Operation

<b>Switching the projector on/off</b> .....	<b>16</b>
Power cord .....	16
Power indicator.....	16
Switching on the projector .....	17
Switching off the projector .....	17
<b>Projecting an image</b> .....	<b>18</b>
Selecting the input signal .....	18
Positioning the image.....	18

## Settings

<b>Menu Navigation</b> .....	<b>19</b>
Navigating through the MENU.....	19
Menu list.....	20
<b>VIERA Link™</b> .....	<b>23</b>
Using the Link functions (VIERA Link).....	23

## Maintenance

<b>TEMP and LAMP Indicators</b> .....	<b>25</b>
Managing the indicated problems .....	25
<b>Care and Replacement</b> .....	<b>26</b>
Cleaning the projector .....	26
Replacing the lamp unit.....	27
<b>Troubleshooting</b> .....	<b>29</b>

## Appendix

<b>Technical Information</b> .....	<b>30</b>
Ceiling mount bracket safeguards.....	30
List of compatible signals .....	31
Specifications .....	32
Trademark acknowledgements .....	34
Dimensions.....	34
<b>Index</b> .....	<b>35</b>

# Precautions with regard to safety

## WARNING

### ■ POWER

**The wall outlet or the circuit breaker shall be installed near the equipment and shall be easily accessible when problems occur. If the following problems occur, cut off the power supply immediately.**

Continued use of the projector in these conditions will result in fire or electric shock.

- If foreign objects or water get inside the projector, cut off the power supply.
- If the projector is dropped or the cabinet is broken, cut off the power supply.
- If you notice smoke, strange smells or noise coming from the projector, cut off the power supply.

Please contact an Authorized Service Center for repairs, and do not attempt to repair the projector yourself.

**During a thunderstorm, do not touch the projector or the cable.**

Electric shocks can result.

**Do not do anything that might damage the power cord or the power plug.**

If the power cord is used while damaged, electric shocks, short-circuits or fire will result.

- Do not damage the power cord, make any modifications to it, place it near any hot objects, bend it excessively, twist it, pull it, place heavy objects on top of it or wrap it into a bundle.

Ask an Authorized Service Center to carry out any repairs to the power cord that might be necessary.

**Insert the power plug securely into the wall outlet.**

If the plug is not inserted correctly, electric shocks or overheating will result.

- Do not use anything other than the provided power cord and ground in the wall outlet.
- Do not use plugs which are damaged or wall outlets which are coming loose from the wall.

**Clean the power plug regularly to prevent it from becoming covered in dust.**

Failure to observe this will cause a fire.

- If dust builds up on the power plug, the resulting humidity can damage the insulation.
- If not using the projector for an extended period of time, pull the power plug out from the wall outlet.

Pull the power plug out from the wall outlet and wipe it with a dry cloth regularly.

**Do not handle the power plug with wet hands.**

Failure to observe this will result in electric shocks.

**Do not overload the wall outlet.**

If the power supply is overloaded (ex., by using too many adapters), overheating may occur and fire will result.

### ■ ON USE/INSTALLATION

**Do not place liquid containers on top of the projector.**

If water spills onto the projector or gets inside it, fire or electric shocks will result.

If any water gets inside the projector, contact an Authorized Service Center.

**Do not place the projector on soft materials such as carpets or sponge mats.**

Doing so will cause the projector to overheat, which can cause burns, fire or damage to the projector.

**Do not set up the projector in humid or dusty places or in places where the projector may come into contact with oily smoke or steam, ex., a bathroom.**

Using the projector under such conditions will result in fire, electric shocks or components deterioration. Components deterioration (such as ceiling mount brackets) may cause the projector which is mounted on the ceiling to fall down.

**Do not install this projector in a place which is not strong enough to take the full weight of the projector or on top of a surface which is sloped or unstable.**

Failure to observe this will cause projector to fall down or tip over the projector, and severe injury or damage could result.

**Do not place another projector or other heavy objects on top of the projector.**

Failure to observe this will cause the projector to become unbalanced and fall, which could result in damage or injury. The projector will be damaged or deformed.

**Installation work (such as ceiling suspension) should only be carried out by a qualified technician.**

If installation is not carried out and secured correctly it can cause injury or accidents, such as electric shocks.

- Do not use anything other than an authorized ceiling mount bracket.
- Be sure to use the provided accessory wire as an extra safety measure to prevent the projector from falling down. (Install in a different location to the ceiling mount bracket)

**Do not cover the air inlet port or the air outlet port.**

Doing so will cause the projector to overheat, which can cause fire or damage to the projector.

- Do not place the projector in narrow, badly ventilated places such as closets or bookshelves.
- Do not place the projector on cloth or papers, as these materials could be drawn into the air inlet port.

### **Do not place your hands or other objects close to the air outlet port.**

Doing so will cause burns or damage your hands or other objects.

- Heated air comes out of the air outlet port. Do not place your hands or face, or objects which cannot withstand heat close to this port.

### **Do not look into or touch the lights emitted from the lens while the projector is being used.**

Doing so can cause burns or loss of sight.

- Strong light is emitted from the projector's lens. Do not look or place your hands directly into this light.
- Be especially careful not to let young children look into the lens. In addition, turn off the power and disconnect the power plug when you are away from the projector.

### **Do not insert any foreign objects into the projector.**

Doing so will cause fire or electric shocks.

- Do not insert any metal objects or flammable objects into the projector or drop them onto the projector.

### **Never attempt to remodel or disassemble the projector.**

High voltages can cause fire or electric shocks.

For any inspection, adjustment and repair work, please contact an Authorized Service Center.

### **Do not use the projector while the projection lens cap is still attached to the projection lens.**

If this is not observed, the lens cap will be damaged and fire will occur.

## ■ ACCESSORIES

### **Do not use or handle the batteries improperly, and refer to the following.**

Failure to observe this will cause burns, batteries to leak, overheat, explode or catch fire.

- Do not use unspecified batteries.
- Use manganese batteries or alkaline batteries.
- Do not disassemble dry cell batteries.
- Do not heat the batteries or place them into water or fire.
- Do not allow the + and – terminals of the batteries to come into contact with metallic objects such as necklaces or hairpins.
- Do not store batteries together with metallic objects.
- Store the batteries in a plastic bag and keep them away from metallic objects.
- Make sure the polarities (+ and –) are correct when inserting the batteries.
- Do not use a new battery together with an old battery or mix different types of batteries.
- Do not use batteries with the outer cover peeling away or removed.
- Remove the empty batteries from the remote control at once.
- Insulate the battery using tape or something similar before disposal.

### **Do not allow children to reach the batteries.**

- The battery can cause death by suffocation if swallowed.
- If swallowed, seek medical advice immediately.

### **If the battery fluid leaks, do not touch it with bare hands, and take the following measures if necessary.**

- Battery fluid on your skin or clothing could result in skin inflammation or injury. Rinse with clean water and seek medical advice immediately.
- Battery fluid coming in contact with your eyes could result in loss of sight. In this case, do not rub your eyes. Rinse with clean water and seek medical advice immediately.

### **Do not disassemble the lamp unit.**

If the lamp breaks, it could cause injury.

### **Lamp replacement**

The lamp has high internal pressure. If improperly handled, an explosion and severe injury or accidents will result.

- Replacement of the lamp should be carried out by a qualified technician.
- The lamp can easily explode if struck against hard objects or dropped.
- Before replacing the lamp, be sure to disconnect the power plug from the wall outlet. Electric shocks or explosions can result if this is not done.
- When replacing the lamp, allow it to cool for at least one hour before handling it otherwise it can cause burns.

### **Do not allow infants or pets to touch the remote control unit.**

- Keep the remote control unit out of the reach of infants and pets after using it.

## CAUTION

### ■ POWER

#### **When disconnecting the power cord, hold the plug, not the cord.**

If the power cord itself is pulled, the cord will become damaged, and fire, short-circuits or serious electric shocks will result.

#### **When not using the projector for an extended period of time, disconnect the power plug from the wall outlet and remove the batteries from the remote control.**

#### **Disconnect the power plug from the wall outlet before carrying out any cleaning.**

Electric shocks can result if this is not done.

## Precautions with regard to safety

### ■ ON USE/INSTALLATION

#### **Do not put your weight on this projector.**

You could fall or the projector could break, and injury will result.

- Be especially careful not to let young children stand or sit on the projector.

#### **Do not place the projector in extremely hot locations.**

Doing so will cause the outer casing or internal components to deteriorate, or result in fire.

- Take particular care in locations exposed to direct sunlight or near stoves.

#### **Always disconnect all cables before moving the projector.**

Moving the projector with cables still attached can damage the cables, which will cause fire or electric shocks to occur.

### ■ ACCESSORIES

#### **Do not use the old lamp unit.**

If used, it could cause lamp explosion.

#### **If the lamp has broken, ventilate the room immediately. Do not touch or bring your face close to the broken pieces.**

Failure to observe this will cause the user to absorb the gas which was released when the lamp broke and which contains nearly the same amount of mercury as fluorescent lamps, and the broken pieces will cause injury.

If you believe that you have absorbed the gas or that the gas has got into your eyes or mouth, seek medical advice immediately.

Ask your dealer about replacing the lamp unit and check the inside of the projector.

#### **Do not place your hands in the openings beside the optical lens, while shifting the lens.**

Failure to observe this could cause injury.

#### **Do not use projectors with the adjustable feet or lens unit cover removed.**

If this not observed, the sets will not operate correctly or accidents will result.

## Cautions when transporting

When transporting the projector or carrying it around, make sure that the lens cap is always in place, and remove the lens. Please take care to keep them away from vibration and impacts, both the projector and the lens are precision-made and easily susceptible to damage.

When transporting the projector, the adjuster legs must be housed and do not hold them. Please securely hold only its bottom and none of its other parts or surfaces as this will result in malfunctions.

## Cautions when installing

### ■ Do not use under the following conditions.

- **Do not set up the projector outdoors.**  
The projector is designed for indoor use only.
- **Avoid setting up in places which are subject to vibration or shocks.**  
If the projector is installed in a place where vibrations are transmitted or mounted in a car or a vessel, vibrations or impacts will result in damage to the internal parts, causing failure. Install the product in a place free from vibrations and impacts.
- **Avoid setting up in places which are subject to sudden temperature changes, such as near an air conditioner or lighting equipment.**  
Failure to observe this will result in malfunctions or the lamp life will be shortened.  
See "TEMP indicator" on page 25.
- **Avoid setting up in places which are near high-voltage power lines or near motors.**  
The product will be exposed to interference if it is installed in the vicinity of high-voltage electrical power lines or power sources.
- **Do not install the projector at elevations higher than 2 700 m (8 858 ft) above sea level.**  
If using this projector at high elevations 1 400 - 2 700 m (4 593 - 8 858 ft) above sea level, set the **HIGH ALTITUDE MODE to ON.**  
Failure to observe this will result in malfunctions or the lamp life or life of other components will be shortened.

### ■ Be sure to ask a specialized technician when installing the product to a ceiling.

If the product is to be installed hanging from the ceiling, purchase an optional hanging attachment (For high ceilings: Model No. ET-PKE1000S, For low ceilings: Model No. ET-PKE2000). Please call a specialized technician or contact an Authorized Service Center for installation.

### ■ Be sure to put on the lens unit cover after installing the projection lens.

If this not done, dust will collect inside the projector and problems with the projector can result.

### ■ Lens Focus

Do not adjust the lens focus in the initial period after switching the projector on. The high clarity projector lens is thermally affected by the light from the light source, making the focus unstable in the period just after switching on. Please allow a warm-up time before adjusting the lens focus.



## Cautions on use

### ■ In order to get the picture quality

Draw curtains or blinds over windows and turn off any lights near the screen to prevent outside light or light from indoor lamps from shining onto the screen. Depending on where the projector is used, air exhaust vents or the warm air from air conditioning can cause a shimmering effect on the screen. For this reason, take care not to shield the air exhaust vents and consider the direction of the air flowing from air conditioning.

- **Do not adjust the lens focus in the initial period (within approx. 30 minutes) after switching the projector on.**

### ■ Do not touch the surface of the projector lens with your bare hand.

If the surface of the lens becomes dirty from fingerprints or anything else, this will be magnified and projected onto the screen. Cover the lens with the lens cap when the projector is not used.

### ■ The projector has a high pressure mercury lamp that is characterized as follows:

- The brightness of the lamp will decrease over time.
- The lamp may explode or shorten the lamp life by shocks or chipping damage.
- In rare cases, it may burst shortly after the first use.
- The possibility of its bursting increases when the lamp is used beyond the replacement time.
- If the lamp bursts, gas inside the lamp is released in the form of smoke.
- The life of a mercury lamp varies according to the individual difference or conditions of use.
- In particular, turning the power on and off frequently and/or repeatedly as well as continuous use for 12 hours will greatly affect the life cycle. Provide a lamp for replacement in advance.

### ■ Connection to external device

When connecting the projector to a computer or external device, use the power cord supplied with the corresponding device and a commercially available shielded interface cable.

### ■ Optical components

It may be necessary to replace the optical components such as liquid crystal panels and polarizing plates in less than 1 year if using the projector in a high temperature environment or in a very dusty, oily smoke or tobacco smoke environment. For more details, please contact your dealer.

### ■ Liquid crystal panel

Do not project the same image for long periods of time, as this may remain as an afterimage on the liquid crystal panel. Display the white screen test pattern for more than an hour to remove it. See the functional instructions that is in the provided CD-ROM.

## Cleaning and maintenance

### ■ Ask an Authorized Service Center to clean the inside of the projector at least once a year.

If dust is left to build up inside the projector without being cleaned out, it can result in fire or problems with operation. It is a good idea to clean the inside of the projector before the season when humid weather arrives.

Ask your nearest Authorized Service Center to clean the projector when required.

Please discuss with the Authorized Service Center regarding cleaning costs.

- **Be sure to remove the power plug from the wall outlet before cleaning.**
- **Use soft and dry cloth to clean the cabinet.**  
Use a soft cloth moistened in warm water to clean away oil. Do not use solvents such as benzene, thinner, and alcohol, detergents for kitchens, or a chemical cloth. If using such solvents, the outer case will become deformed, and the paint may peel off.
- **Do not clean the lens surface with fuzzy or dusty cloths.**

If dust adheres to the lens, it will be magnified and projected on the screen. Use a soft and clean cloth to wipe off dust.

## Disposal



When discarding this product, please contact your local authorities or dealer and ask for the correct method of disposal.

# Precautions with regard to safety

## Accessories

Make sure the following accessories are provided with your projector.

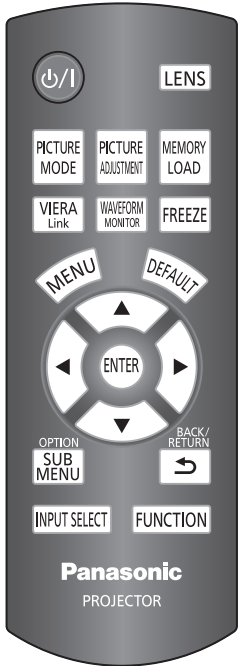
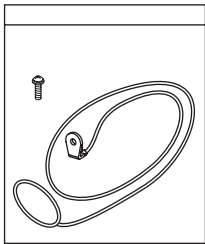
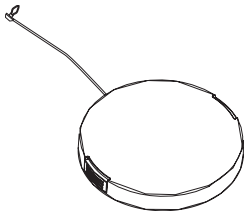
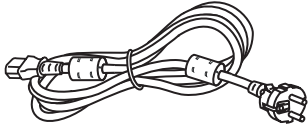
Important Information

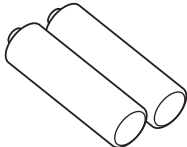
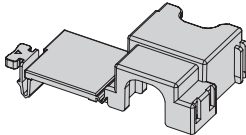
<p><b>Remote control for N2QAYB000450</b></p> 	<p><b>Safety cable</b> TTRA0141 Attachment screw (x1) Safety cable (x1)</p> 	<p><b>Lens cover (x1)</b> TXFKK01REGZ (Attached to the projector by default.)</p> 
	<p><b>Power cord (x1)</b> K2CG3FH00019 3 m (9'10 1/8")</p> 	<p><b>CD-ROM (x1)</b> TXFQB02REGZ</p> 
	<p><b>AA batteries for remote control (x2)</b></p> 	<p><b>Power cord secure lock (x1)</b> TTRA0182</p> 

\* The protectors for enclosed products, such as a plug cover or foam cartons, must be treated properly.

\* Contact an Authorized Service Center for lost accessories.

# About Your Projector

## Remote control

### Power button

While **MAIN POWER** is on, switch between standby mode and projection mode.

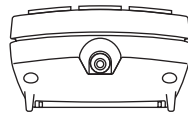

**Remote control signal emitter**  
Emit remote control signal.

### Button backlight

When any button is pressed, the button backlight is lit. Without any operation, it gets darker after 5 seconds and goes off after next 5 seconds.

Display the **PICTURE** menu or **ADVANCED MENU**.

PICTURE ADJUSTMENT

Switch to cycle through the **PICTURE MODE**.

PICTURE MODE

Display the **VIERA LINK** menu.

VIERA Link

Display the main menu or return to the previous menu.

MENU

Navigate through the menus with ▲▼◀▶, and activate the menu item with the **ENTER** button.

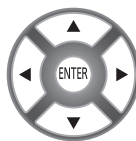

Open the connected equipment menu while using the **VIERA Link**.

SUB MENU

Switch to cycle through the input method.

INPUT SELECT

**LENS** Display the **ZOOM/FOCUS** menu.

**MEMORY LOAD** Display the **MEMORY LOAD** menu.

**FREEZE** Capture the projected image as a still image.

**WAVEFORM MONITOR** Display the input waveform.

**DEFAULT** Reset some of the settings to the factory default.

**BACK/RETURN** Return to the previous menu.

**FUNCTION** Activate the assigned function from the menu options for shortcut.

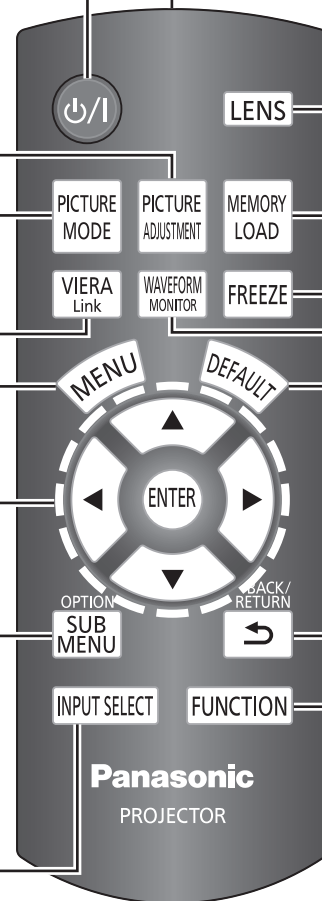

### Battery compartment

1. Press the tab and lift up the cover.
2. Insert the batteries according to the polarity diagram indicated inside.

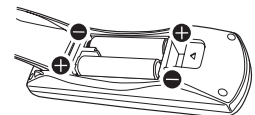

### Note:

- See the functional instructions that is in the provided CD-ROM for more details.
- Do not drop the remote control.
- Avoid contact with liquids or moisture.
- Use manganese batteries or alkaline batteries with the remote control.
- Do not attempt to modify or disassemble the remote control. Contact an Authorized Service Center for repairs.
- Do not keep pressing the remote control buttons as this may shorten battery life.

# About Your Projector

## Projector body

### Top and front view

Preparation

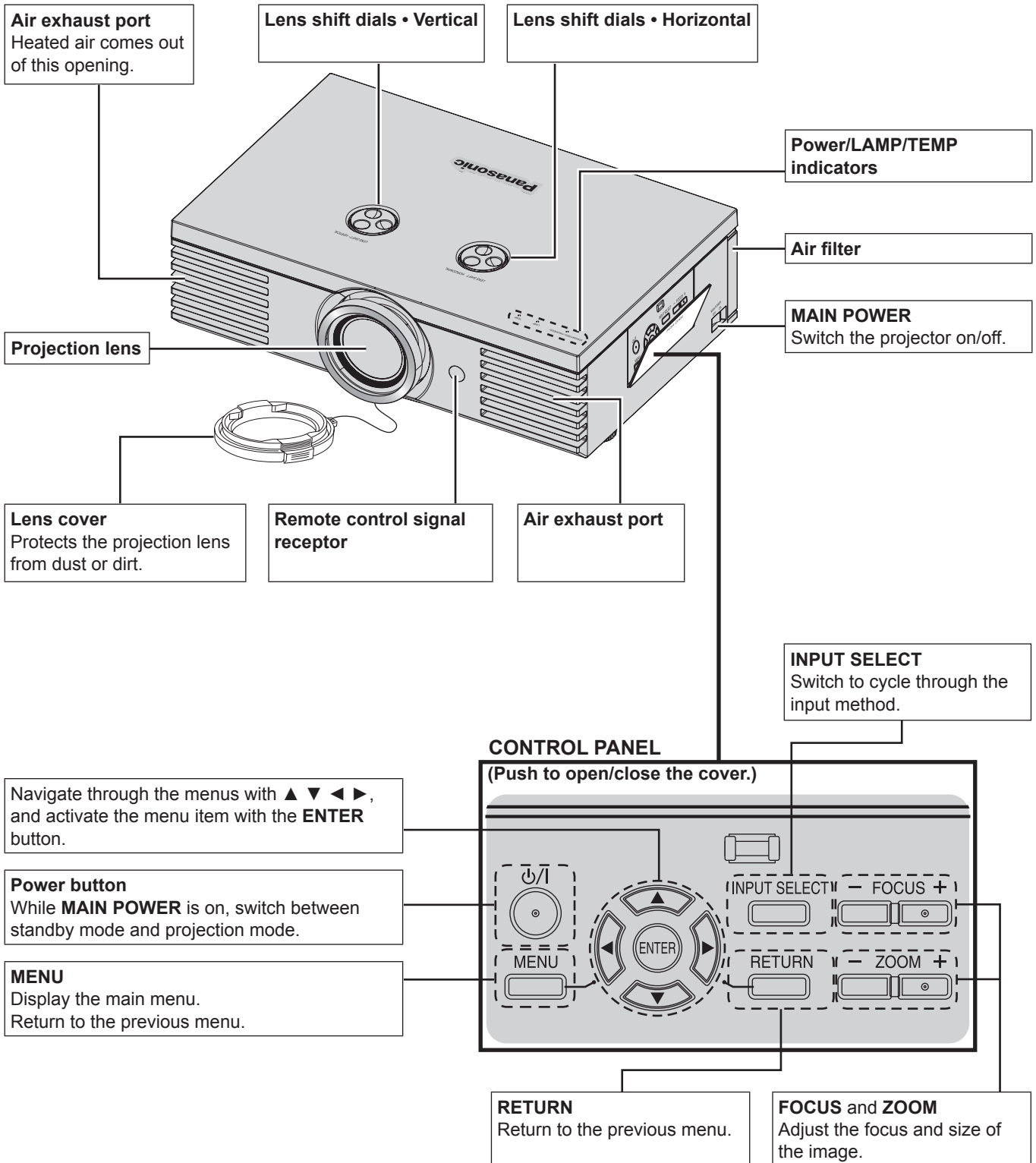

## Back and bottom view

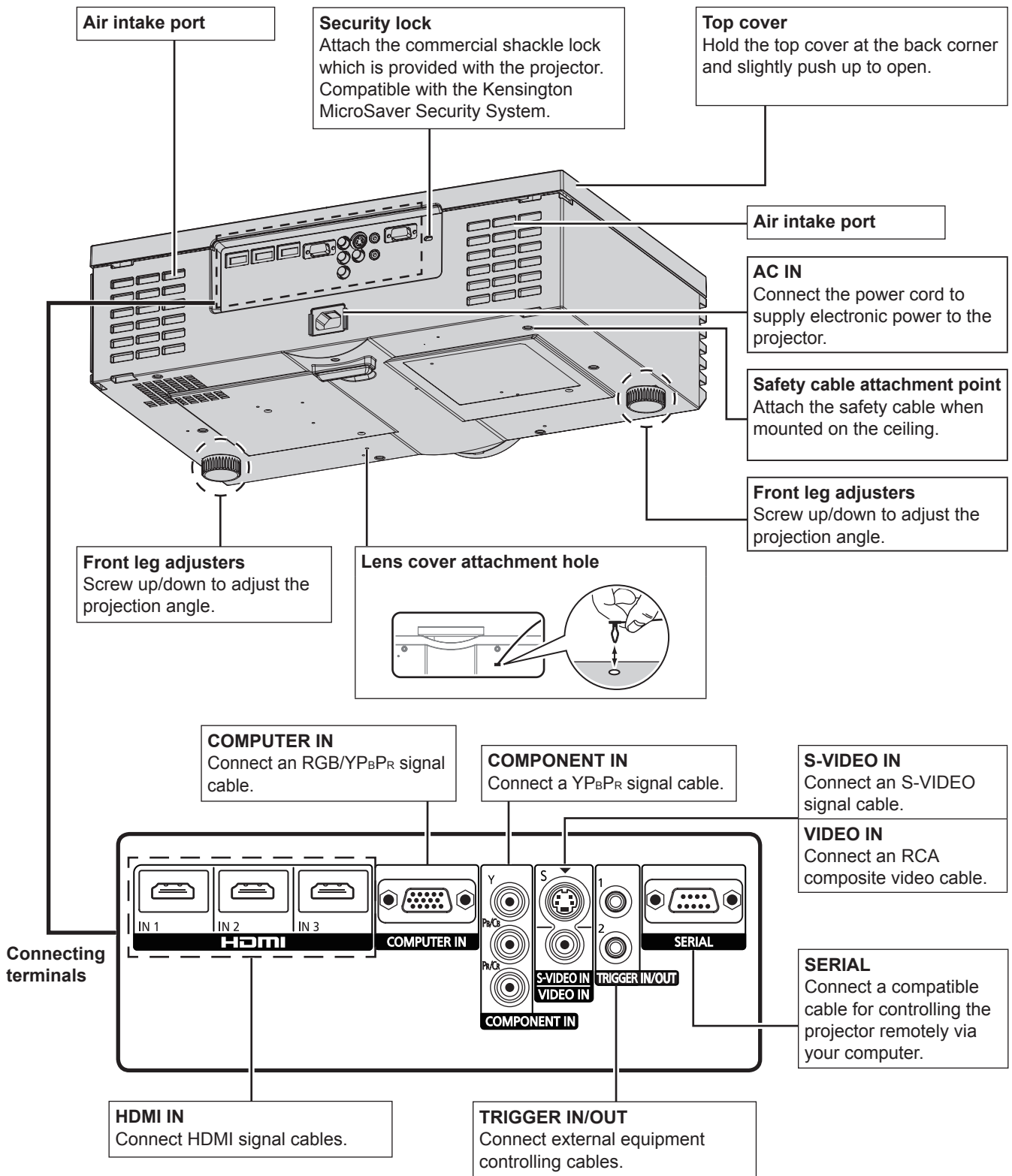

**NOTE:**

- The projector should only be used with the attached power cord to ensure optimum performance and avoid damage to the projector.
- Do not open the top cover other than replacing the lamp unit.
- See the functional instructions that is in the provided CD-ROM for more details.

# Setting up

## Screen size and throw distance

You can adjust the projection size with 2 × zoom lens. Calculate and define the throw distance as follows.

Projected image

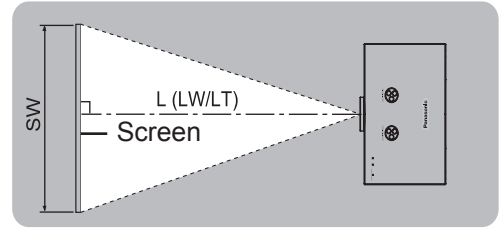
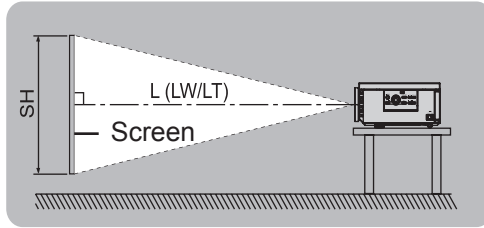
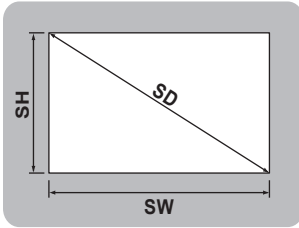

All measurements and the calculation results below are approximate and may differ from the actual measurements.

Screen Diagonal (SD)	Throw distance (16:9)		Throw distance (2.35:1)	
	Minimum distance (LW)	Maximum distance (LT)	Minimum distance (LW) <sup>*1</sup>	Maximum distance (LT)
2.03 m (80")	2.4 m (7'10")	4.7 m (15'5")	2.6 m (8'6")	3.8 m (12'5")
2.54 m (100")	3.0 m (9'10")	5.9 m (19'4")	3.2 m (10'6")	4.7 m (15'5")
3.05 m (120")	3.6 m (11'9")	7.2 m (23'7")	3.8 m (12'5")	5.7 m (18'8")

\*1. When using both 2.35:1 and 16:9 aspect images onto a 2.35:1 sized screen.

### Calculation methods for screen dimensions

You can calculate more detailed screen dimensions from the screen diagonal.

	16:9 size	2.35:1 size
Screen height (SH)	= SD (m) × 0.490	= SD (m) × 0.392
Screen width (SW)	= SD (m) × 0.872	= SD (m) × 0.920
Minimum distance (LW)	= SD (m) × 1.189 - 0.04	= SD (m) × 1.256 - 0.04
Maximum distance (LT)	= SD (m) × 2.378 - 0.05	= SD (m) × 1.899 - 0.05

#### NOTE:

- You can tilt the projector body less than approximately ±30° vertically and ±10° horizontally. Overtilting may result in shortening the component's life.
- Do not cover the air exhaust/intake ports or place anything within 50 cm (19 5/8") of them.

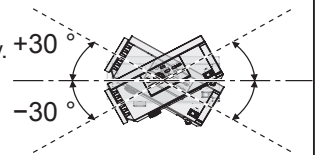

## Projection method

You can use the projector with any of the following 4 projection methods. To set the projector in the desired method, see "INSTALLATION" in "OPTION menu" of the functional instructions that is in the provided CD-ROM.

### Mounting on the ceiling and projecting from front

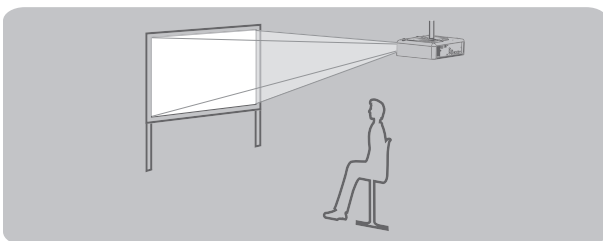

INSTALLATION: FRONT/CEILING

### Setting on a desk/floor and projecting from rear

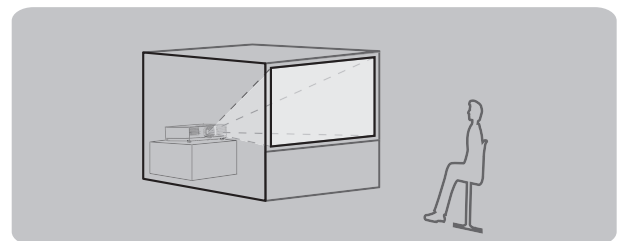

INSTALLATION: REAR/DESK

### Mounting on the ceiling and projecting from rear

INSTALLATION: REAR/CEILING

### Setting on a desk/floor and projecting from front

INSTALLATION: FRONT/DESK

#### NOTE:

- A translucent screen is required for rear projection.
- When mounting the projector on the ceiling, the optional ceiling mount bracket (ET-PKE2000, ET-PKE1000S) is required.
- See "Ceiling mount bracket safeguards" on page 30.

## Lens shift and positioning

If the projector is not positioned right in front of the center of the screen, you can adjust the projected image position by moving the lens shift dials within the shift range of the lens.

### Adjusting the lens shift dials

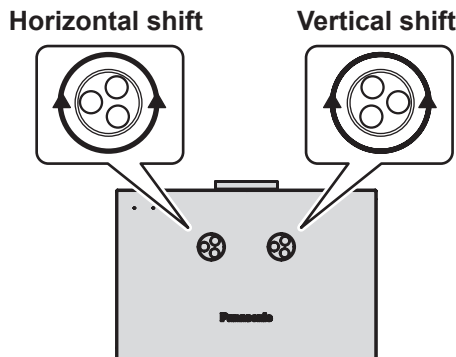

#### Horizontal shift

You can place the projector where the projector lens is up to 40 % horizontally off-center from the screen and then adjust the image position with the **Lens shift dial • Horizontal**.

Up to about 40 % of the projection      Up to about 40 % of the projection

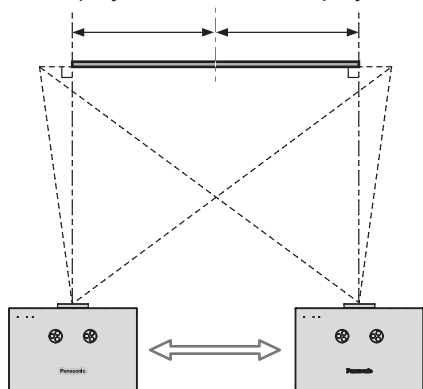

Turning the dial clockwise:  
Image moves to the right

Turning the dial counterclockwise:  
Image moves to the left

#### Vertical shift

You can place the projector where the projector lens is up to 100 % vertically off-center from the screen and then adjust the image position with the **Lens shift dial • Vertical**.

Turning the dial counterclockwise:  
Image moves to the bottom

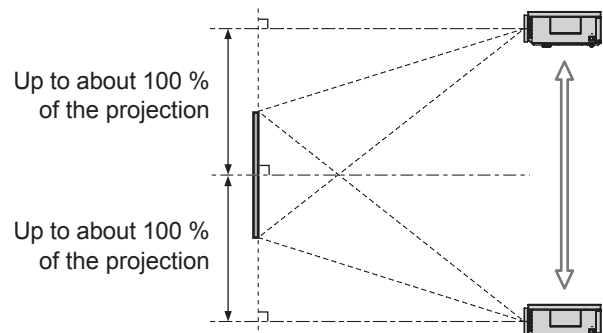

Turning the dial clockwise:  
Image moves to the top

## Connections

### Before connecting to the projector

- Read and follow the operating and connecting instructions of each peripheral device.
- The peripheral devices must be turned off.
- Use cables that match each peripheral device to be connected.
- Confirm the type of video signals. See "List of compatible signals" on page 31.
- Audio cables must be connected from each peripheral device directly to the audio reproduction system.

#### NOTE:

- See the functional instructions that is in the provided CD-ROM.

# Switching the projector on/off

## Power cord

### Connecting

1. Make sure the shape of the power plug and the **AC IN** terminal on the back of the projector match, then push the plug all the way in.
2. Align the side of the power cord secure lock with the side guide rail of the **AC IN** terminal of the projector and slide it in.
3. Place the latch to the latch catcher and press until it clicks.

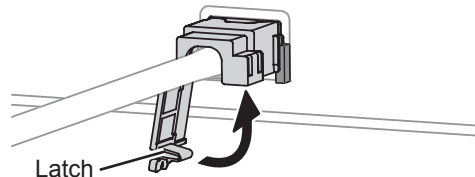
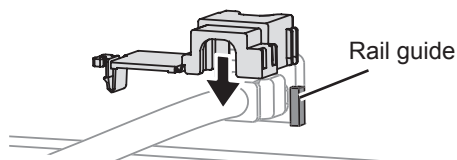

4. Connect the power cord to a wall outlet.

### Disconnecting

1. Unplug the power cord from the wall outlet.
2. Depress the latch and slide the cover off.
3. Slide the power cord secure lock up along the side guide rail.
4. Hold the plug and unplug it from the **AC IN** terminal on the back of the projector.

#### NOTE:

- Do not use other than the provided power cord.
- Ensure all the input devices are connected and turned off before connecting the power cord.
- Do not force the connector as this may damage the projector and/or the power cord.
- Dirt or dust build-up around plugs may cause fire or electrical hazards.
- Switch off the power to the projector when not in use.

## Power indicator

Power indicator informs you of the status of the power.

- When the **TEMP** indicator is flashing, the power indicator will turn red, and you cannot switch on the power.

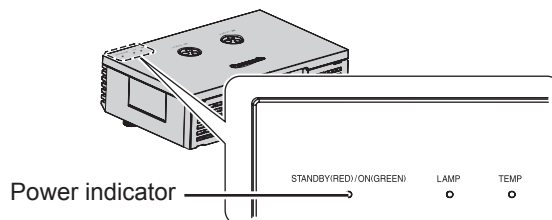

Indicator status		Status
No illumination or flashing		<b>MAIN POWER</b> is switched off.
Red	Lit	<b>MAIN POWER</b> is switched on and the projector is in standby mode.
	Flashing	<b>MAIN POWER</b> is switched on (standby mode) and the <b>POWER ON LINK</b> is set to <b>YES</b> . • The power consumption is not much different when it is lit. (See "VIERA Link Connection" of the functional instructions that is in the provided CD-ROM.)
Green	Flashing	The power button is switched on and the projector is getting ready to project.
	Lit	Projecting.
Orange	Lit	The power button is switched off and the projector is cooling the lamp.
	Flashing	The power button is switched on again when cooling the lamp and recovering to projection mode. Recovery may take a while.

#### NOTE:

- See "TEMP indicator" on page 25.
- While the projector is cooling the lamp, do not switch **MAIN POWER** off or unplug the power cord.
- The electric consumption in standby mode is 0.08 W.



## Switching on the projector

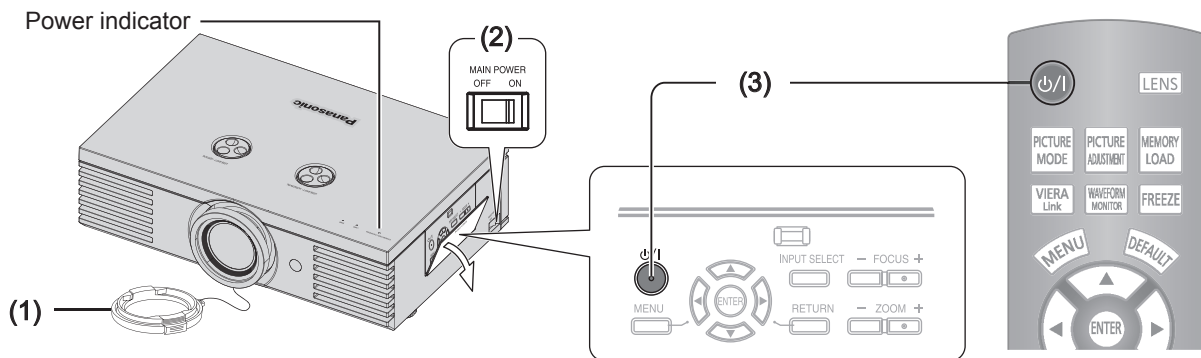

1. Remove the lens cover from the lens.
2. Switch **MAIN POWER** on.
  - The power indicator lights up in red.
3. Press the power button.
  - The power indicator lights up in green after flashing for a while.
  - The **STARTUP LOGO** is displayed on the screen. See "STARTUP LOGO" in "OPTION menu" of the functional instructions that is in the provided CD-ROM.

### NOTE:

- When the internal cooling fan is operating, some operational sound may be heard. The loudness of the operational sound depends on the external temperature.
- You can reduce the operational sound by setting the **LAMP POWER** in **OPTION** menu to the **ECO-MODE**. See "LAMP POWER" in "Option menu" of the functional instructions that is in the provided CD-ROM.
- When starting up the projector, some small rattling or tinkling sound may be heard, or the display may flicker for the characteristics of the lamp. Those are normal and will not affect the performance of the projector.
- Do not attempt to modify the lens cover which may cause burns, fire or damage to the projector.

## Switching off the projector

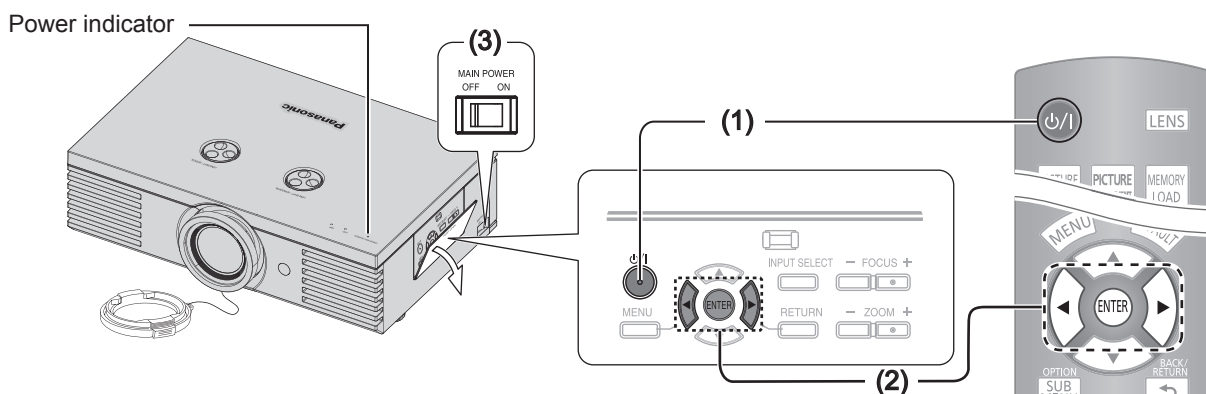

1. Press the power button.
  - The confirmation screen is displayed.
  - To return to the projection, press the **MENU** or **RETURN** button.
2. Press the power or **ENTER** button.
  - The power indicator lights up in orange while cooling the lamp, then illuminates red when it is ready to switch off **MAIN POWER**.
3. Switch off **MAIN POWER** on the left side of the projector.
4. Attach the lens cover.

### NOTE:

- Press the power button twice or for a long duration to switch the power off.

# Projecting an image

## Selecting the input signal

1. Switch on the connected devices.
  - Press the play button of the required device.
2. Press the **INPUT SELECT** button to select the required input method if needed. See “Switching the input signal” of the functional instructions that is in the provided CD-ROM.
  - The image will be projected on the screen.

### NOTE:

- **AUTO SEARCH** is **ON** as default and the signal from the connected devices is detected automatically. See “AUTO SEARCH” in “OPTION menu” of the functional instructions that is in the provided CD-ROM.

## Positioning the image

1. Adjust the projected image with the lens shift dials.  
See “Lens shift and positioning” on page 15.
3. Adjust the focus and the projected image size.
  - Press +/- of the **FOCUS** and **ZOOM** buttons to adjust.
  - Press the **LENS** button to adjust the focus and zoom by the remote control. See “LENS CONTROL” of the functional instructions that is in the provided CD-ROM.

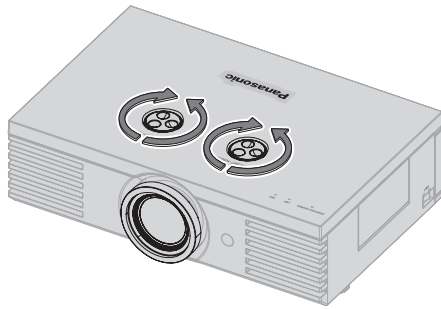

2. Adjust the angle of the projector.
  - You can screw the front leg adjusters up/down to control the angle of the projector for adjusting the throwing angle.
  - Screw up the front leg adjusters, and an audible click will be heard as the limit.

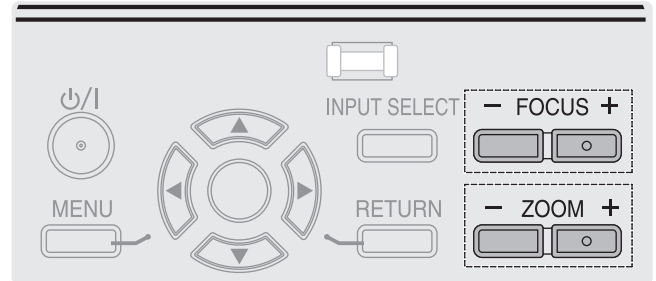
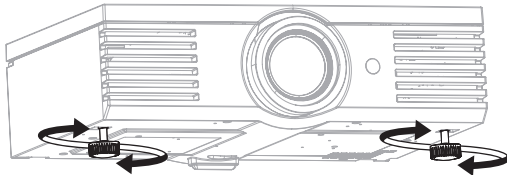

### NOTE:

- Do not touch the air exhaust port as this may cause burns or injury.
- If keystone distortion occurs, see “KEYSTONE” in “POSITION menu” of the functional instructions that is in the provided CD-ROM.
- If you adjust the focus, you may need to adjust the size of the image by pressing the **ZOOM** button again.

# Menu Navigation

## Navigating through the MENU

### Displaying the main menu



Press the **MENU** button to display the main menu and the operating guidance.

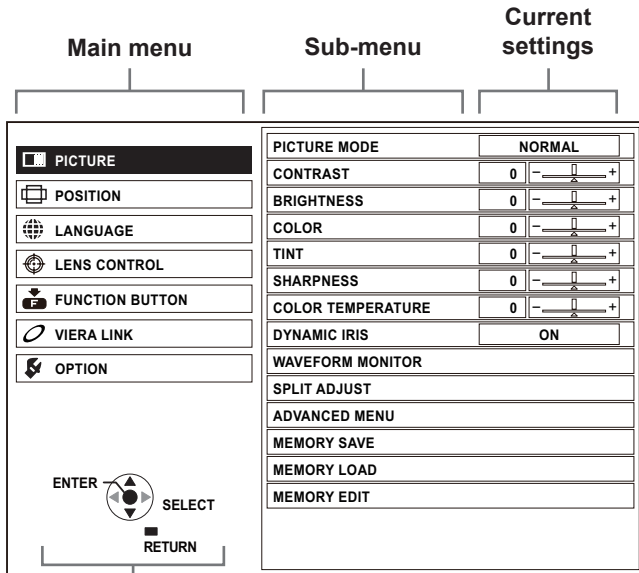

#### Operating guidance

Contains the required buttons to adjust the settings.

### Adjusting with the bar scale items

The triangle mark under the bar indicates factory default setting and the square indicates the current setting.

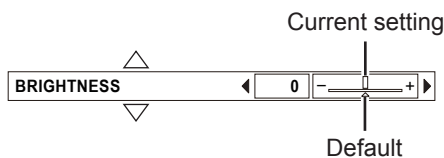

### Returning to the previous menu



Press the **MENU** or **RETURN** button to return to the previous menu. Press repeatedly to escape from the menu mode and return to the projection.

### Resetting to the factory default settings



You can reset most of the customized settings to the factory defaults by pressing **DEFAULT** button of the remote control.

### Operating procedure

- Press **▲ ▼** to scroll to the required main menu item and press the **ENTER** button to select.
  - The selected item is highlighted in orange and the sub-menu is displayed on the right.
  - See "Menu list" on page 20.

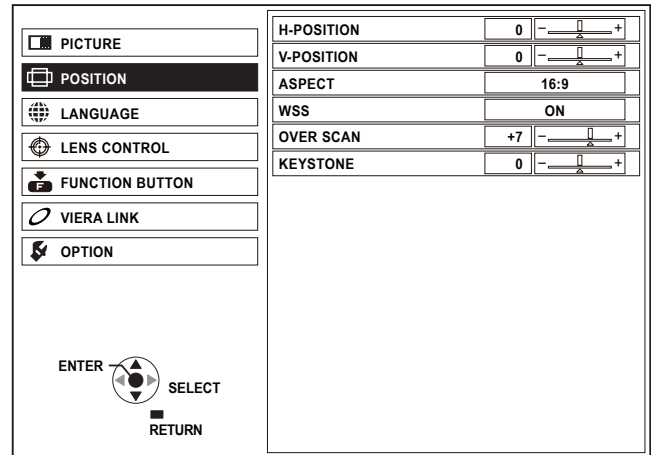

- Press **▲ ▼** to scroll to the required sub-menu item and press **◀ ▶** or the **ENTER** button to adjust.
  - The selected item is called up and the other menu items disappear from the screen. The Called up item will disappear after 5 seconds without any operation and return to the menu mode.
  - If there is a lower level to the sub-menu item, the next level will be displayed.

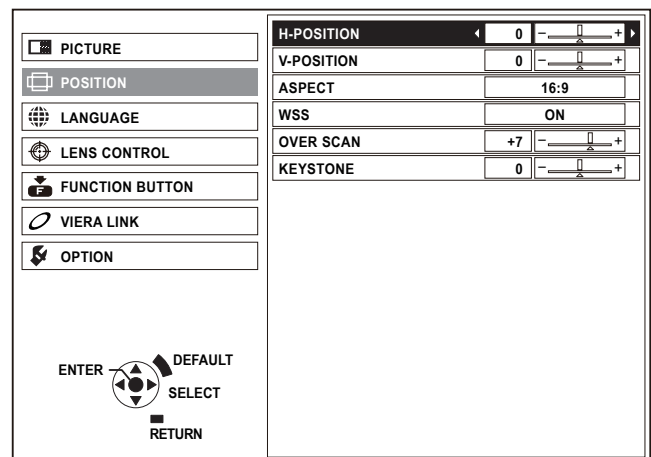

- Press **◀ ▶** to adjust or set the selected item.
  - For items using a bar scale, the current settings are displayed on the left of the bar scale.
  - You can cycle through the options of an item by pressing **▲ ▼**.



- Press the **MENU** or **RETURN** button to return to the previous menu.

## Menu list

The menu options are structured and categorized. You can navigate through the menu with ▲ ▼ ◀ ▶ buttons.

**NOTE:**

- The underlined items are factory default settings.
- Some default settings vary by the selected input signal.
- Sub-menu items vary according to the selected input signal.
- Some settings are adjustable without any signals.



### PICTURE

- It is possible to adjust the picture quality.

#### PICTURE MODE

<u>NORMAL</u>	<u>DYNAMIC</u>
COLOR1	COLOR2
CINEMA1	CINEMA2
CINEMA3	

#### CONTRAST

(Default: 0)

#### BRIGHTNESS

(Default: 0)

#### COLOR

(Default: 0)

#### TINT

(Default: 0)

#### SHARPNESS

(Default: 0)

#### COLOR TEMPERATURE

(Default: 0)

#### DYNAMIC IRIS

ON OFF

#### WAVEFORM MONITOR

OFF

FULL SCAN(Y)	FULL SCAN(R)
FULL SCAN(G)	FULL SCAN(B)
SINGLE LINE SCAN(Y)	
SINGLE LINE SCAN(R)	
SINGLE LINE SCAN(G)	
SINGLE LINE SCAN(B)	

#### MONITOR POSITION

<u>UPPER LEFT</u>	UPPER CENTER
UPPER RIGHT	LOWER LEFT
LOWER CENTER	LOWER RIGHT

#### AUTO ADJUST

START AUTO ADJUST  
 BLACK LEVEL ADJUST  
 WHITE LEVEL ADJUST  
 RGB ADJUST (BLACK)  
 RGB ADJUST (WHITE)

#### SPLIT ADJUST

AREA SELECT  
 SPLIT ADJUST MODE  
 NORMAL REVERSE

#### ADVANCED MENU

##### GAMMA ADJUSTMENT

SIMPLE	<u>ADVANCED</u>
CONTRAST R	(Default: 0)
CONTRAST G	(Default: 0)
CONTRAST B	(Default: 0)
BRIGHTNESS R	(Default: 0)
BRIGHTNESS G	(Default: 0)
BRIGHTNESS B	(Default: 0)
NR	(Default: 0)
MPEG NR	(Default: 0)

##### FRAME CREATION

OFF	<u>MODE1</u>
MODE2	MODE3

##### COLOR MANAGEMENT

PROFILE	<u>ADJUSTMENT MODE</u>
START ADJUSTMENT	LOG
PROFILE SAVE	PROFILE DELETE
PROFILE NAME CHANGE	

##### x.v.Color

<u>ON</u>	OFF
DETAIL CLARITY	(Default: 3)

##### CINEMA REALITY

ON OFF

##### TV-SYSTEM

<u>AUTO</u>	
NTSC	NTSC 4.43
PAL	PAL-M
PAL-N	SECAM

##### RGB/YPbPr

<u>AUTO</u>	RGB	YPbPr
-------------	-----	-------

#### MEMORY SAVE

MEMORY 1 - 16

#### MEMORY LOAD

MEMORY 1 - 16

#### MEMORY EDIT

MEMORY DELETE	
MEMORY 1 - 16	ALL DELETE
MEMORY NAME CHANGE	
MEMORY 1 - 16	

#### SIGNAL MODE

## POSITION

- It is possible to adjust the image size and position.

### H-POSITION

(Default: 0)

### V-POSITION

(Default: 0)

### DOT CLOCK

(Default: 0)

### CLOCK PHASE

(Default: 0)

### ASPECT

4:3	16:9	s16:9	14:9
ZOOM	ZOOM1	ZOOM2	JUST
AUTO	H-FIT	V-FIT	

### WSS

ON OFF

### OVER SCAN

### KEystone

(Default: 0)

### AUTO SETUP

## LANGUAGE

- It is possible to change the display language.

DEUTSCH	POLSKI
FRANÇAIS	ČEŠTINA
ESPAÑOL	MAGYAR
ITALIANO	РУССКИЙ
PORTUGUÊS	ไทย
SVENSKA	한국어
NORSK	ENGLISH
DANSK	中文
	日本語

## LENS CONTROL

- It is possible to adjust the lens position.

### ZOOM/FOCUS

### LENS MEMORY LOAD

LENS MEMORY 1 - 6

### LENS MEMORY SAVE

LENS MEMORY 1 - 6

### LENS MEMORY EDIT

LENS MEMORY DELETE  
LENS MEMORY 1 - 6 ALL DELETE  
LENS MEMORY NAME CHANGE  
LENS MEMORY 1 - 6

### AUTO SWITCHING

2.35:1 IMAGE DETECTION  
OFF LENS MEMORY 1 - 6  
16:9 IMAGE DETECTION  
OFF LENS MEMORY 1 - 6

### H-AREA POSITION

(Default: 0)

### V-AREA POSITION

(Default: 0)

### LEFT MASKING AREA

(Default: 0)

### RIGHT MASKING AREA

(Default: 0)

### UPPER MASKING AREA

(Default: 0)

### LOWER MASKING AREA

(Default: 0)

## FUNCTION BUTTON

- It is possible to assign a useful function to the **FUNCTION** button.

### COLOR MANAGEMENT

GAMMA ADJUSTMENT

SPLIT ADJUST

WAVEFORM AUTO ADJUST

FRAME CREATION

NORMAL

DYNAMIC

COLOR1

COLOR2

CINEMA1

CINEMA2

CINEMA3

TEST PATTERN

OPERATE OTHER DEVICE

ASPECT

AUTO SETUP

CONTRAST

BRIGHTNESS

BLANK

HDMI 1 IN

HDMI 2 IN

HDMI 3 IN

COMPUTER IN

COMPONENT IN

S-VIDEO IN

VIDEO IN

## VIERA LINK

- It is possible to link with the connected equipment.

### VIERA LINK CONTROL

RECORDER 1 - 3

PLAYER 1 - 3

HOME THEATER 1 - 3

CAMCORDER 1 - 3

LUMIX 1 - 3

OTHER 1 - 4

### HOME THEATER VOLUME

### HOME THEATER MUTE

### OPERATE OTHER DEVICE

## OPTION

- It is possible to change the option settings.

<b>INPUT GUIDE</b>	
<u>DETAILED</u>	OFF
SIMPLE	
<b>OSD DESIGN</b>	
<u>TYPE1</u>	TYPE2
TYPE3	
<b>OSD POSITION</b>	
<u>CENTER</u>	LOWER LEFT
LOWER CENTER	LOWER RIGHT
UPPER LEFT	UPPER CENTER
UPPER RIGHT	
<b>BACK COLOR</b>	
<u>BLUE</u>	BLACK
<b>STARTUP LOGO</b>	
<u>ON</u>	OFF
<b>AUTO SEARCH</b>	
<u>ON</u>	OFF
<b>HDMI SIGNAL LEVEL</b>	
<u>NORMAL</u>	EXPAND
<b>FRAME RESPONSE</b>	
<u>NORMAL</u>	FAST
<b>INSTALLATION</b>	
<u>FRONT/DESK</u>	FRONT/CEILING
REAR/DESK	REAR/CEILING
<b>TRIGGER 1/2 SETTING</b>	
<u>OFF</u>	
OUTPUT	
POWER ON	
SELECT LENS MEMORY 1 - 6	
BLANK	
SELECT 4:3 ASPECT	
SELECT 16:9 ASPECT	
SELECT S16:9 ASPECT	
SELECT JUST ASPECT	
SELECT ZOOM ASPECT	
SELECT H-FIT ASPECT	
SELECT V-FIT ASPECT	
RS-232C COMMAND LINK	

<b>DELAY TIME</b>			
<u>0 SEC.</u>	2 SEC.	4 SEC.	6 SEC.
8 SEC.	10 SEC.	20 SEC.	30 SEC.
<b>INPUT</b>			
POWER ON/OFF		BLANK	
<b>SLEEP</b>			
<u>OFF</u>	60 MIN.	90 MIN.	120 MIN.
150 MIN.	180 MIN.	210 MIN.	240 MIN.
<b>HIGH ALTITUDE MODE</b>			
<u>OFF</u>		ON	
<b>LAMP POWER</b>			
<u>NORMAL</u>		ECO-MODE	
<b>VIERA LINK SETTINGS</b>			
<b>VIERA LINK</b>			
<u>ON</u>		OFF	
<b>POWER ON LINK</b>			
<u>NO</u>		YES	
<b>POWER OFF LINK</b>			
<u>YES</u>		NO	
<b>STAND-BY POWER SAVE</b>			
<u>NO</u>		YES	
<b>AUTO POWER STAND-BY</b>			
<u>NO</u>		YES (WITH REMINDER)	
YES (NO REMINDER)			
<b>VERSION</b>			
<b>TEST PATTERN</b>			
<b>LAMP RUNTIME</b>			

### NOTE:

- See the functional instructions that is in the provided CD-ROM for more details.

## Using the Link functions (VIERA Link)

### VIERA Link Control

You can control some functions of the connected equipment with this projector remote control.

- If you cannot operate, check the settings and the equipment.
- For details of the operations for the connected equipment, please read the manual of the equipment.

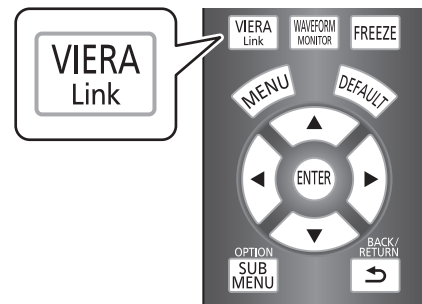

### Access and operate the menu of the equipment

1. Press the **VIERA Link** button and display the **VIERA LINK** menu.
2. Press **▲ ▼** to select **VIERA LINK CONTROL**.
3. Press **◀ ▶** to select the type of equipment you want to access from **VIERA LINK CONTROL** and press the **ENTER** button.

(**RECORDER/PLAYER/HOME THEATER/CAMCORDER/LUMIX/OTHER**)

- “**HOME THEATER**” means Player theater, Blu-ray Disc theater or Recorder theater.
- “**OTHER**” means Tuner (set-top box), etc.



**The menu of the accessed equipment**  
(Input mode will be changed automatically.)

4. Operate the menu of the equipment
  - Projector remote control can be used. (Controllable functions depend on the connected equipment.)

#### If you access non-VIERA Link equipment

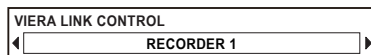

The type of the connected equipment is displayed. You can access the menu of the equipment. But you cannot operate it. Please use its own remote control to operate the equipment.

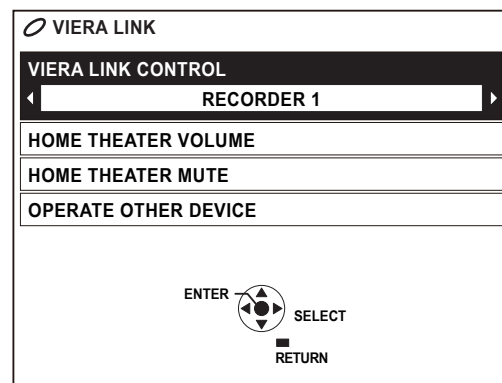

#### If multiple recorders or players are connected

You can connect up to three recorders or players at the same time.

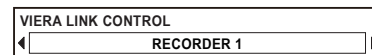

**Recorder 1 - 3/Player 1 - 3**

Some type of equipment is indicated by a number following the device name in the order of ascending HDMI terminal connection. For example, if two recorders are connected to HDMI2 and HDMI3, in this case the recorder connected to HDMI2 is displayed as “Recorder 1”, and the recorder connected to HDMI3 is displayed as “Recorder 2”.

#### NOTE:

- Some operations may not be available depending on the equipment. In this case use its own remote control to operate the equipment.  
(For example)  
The colored buttons operations, such as changing the date of TV program list for Blu-ray Disc Recorder cannot be controlled by the projector remote control.

## Speaker control

You can control the theater speaker with this projector remote control.

- If you cannot operate, check the settings and the equipment.

### Access and operate the speaker volume

1. Select **HOME THEATER VOLUME** in the **VIERA LINK** menu and press the **ENTER** button.
  - Volume side bar will be displayed.
2. Press ◀ ▶ to adjust the volume of the equipment.

### MUTE setting

1. Select **HOME THEATER MUTE** in **VIERA LINK** menu and press the **ENTER** button.
  - You can switch to turn off/on the sound by pressing the **ENTER** button.

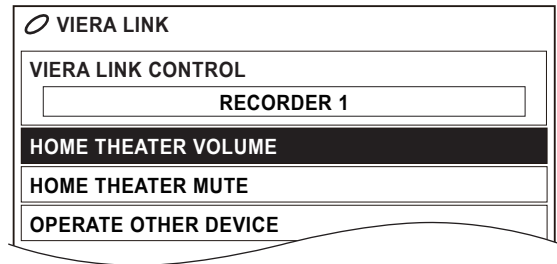

### NOTE:

- These functions may not work properly depending on the connected equipment.
- Image or sound may not be available for the first few seconds when input mode is switched.
- **HDAVI Control 4** is the newest standard (current as of August, 2009) for HDAVI Control compatible equipment. This standard is compatible with conventional HDAVI equipment.
- **HOME THEATER** (Player theater, Blu-ray Disc theater or Amplifier) will be automatically turned on if it is in standby mode, and the sound from the theater speakers connected to the equipment is turned on.

## Other manufacturer's equipment control

You can control other manufacturer's connected equipment by the projector remote control.

### Access and operate the menu of the other manufacturer's equipment

1. Press the **VIERA Link** button on the remote control.
  - The **VIERA LINK** menu will be displayed.
2. Press ◀ ▶ to select your required equipment from the **VIERA LINK CONTROL** menu.
3. Press the **ENTER** button.
  - Your selected equipment will be switched to the HDMI input which is connected to the projector.
4. Select **OPERATE OTHER DEVICE** and press the **ENTER** button.
5. Remote control image will appear on the screen, so please follow it to operate.

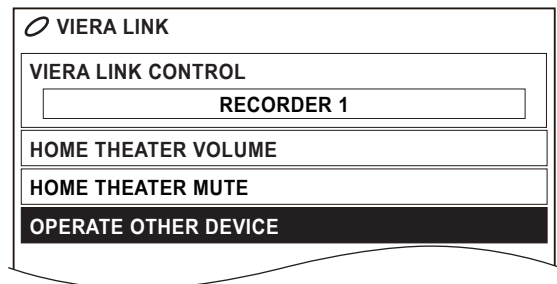

### NOTE:

- See "VIERA Link Connection" of the functional instructions that is in the provided CD-ROM.



# TEMP and LAMP Indicators

## Managing the indicated problems

If a problem should occur with the projector, the **LAMP** and/or **TEMP** indicators will inform you. Manage the indicated problems as follows.

1. Confirm the status of all indicators and projector, and switch off the projector in proper way.
2. Find out the cause of the problem by status of the **LAMP** and/or **TEMP** indicators.
3. Follow the following instruction for each indication and solve the problem.
4. Turn on the projector in the correct way and confirm the indicator is not indicating a problem any longer.

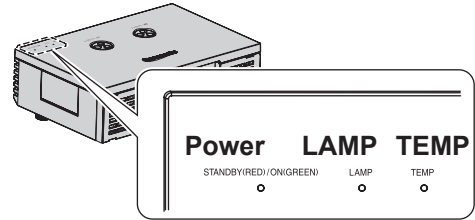

### TEMP indicator

<b>Indicator</b>	<ul style="list-style-type: none"> <li>● Illuminating red while projecting and the alert will be displayed.</li> <li>● Flashing red and the power button is turned off automatically.</li> <li>● When the <b>TEMP</b> indicator is lit, the lamp might have darkened. Adjustments can be performed but not all changes will be shown on the image.</li> </ul>			
<b>Problem</b>	The temperature inside and/or outside the projector is abnormally high.			
<b>Cause</b>	The air intake and exhaust ports are covered.	The room temperature is too high.	The air filter is excessively dirty and the ventilation is poor.	The projector is located at high elevations (above 1 400 - 2 700 m).
<b>Remedy</b>	Remove the object(s) from the ventilation openings or clear around the projector.	Reinstall the projector in a temperature controlled place. See page 32.	Clean or replace the air filter in the proper method. See page 26.	Turn on the projector and set the <b>HIGH ALTITUDE MODE</b> to <b>ON</b> . See "INSTALLATION" of the functional instructions that is in the provided CD-ROM.

### LAMP indicator

<b>Indicator</b>	Illuminating red	Flashing red		
<b>Problem</b>	<b>LAMP RUNTIME</b> has reached 1 800 hours.	Lamp circuit failure, abnormal function or lamp unit is damaged.		
<b>Cause</b>	The lamp unit will run out soon and needs to be replaced.	The power is turned on again before the lamp unit is cooled enough.	Lamp circuit failure, abnormal function.	The lamp unit is damaged.
<b>Remedy</b>	See "Replacing the lamp unit" on page 27.	Let the lamp unit cool down and turn on the power after 90 seconds.	Contact an Authorized Service Center.	See "Replacing the lamp unit" on page 27.

#### NOTE:

- If no problem is found or the problem remains, do not turn on the projector. Instead contact an Authorized Service Center.

# Care and Replacement

## Cleaning the projector

### Before cleaning the projector

- Switch off **MAIN POWER** in proper way and disconnect the power plug from the wall outlet.
- Unplug all the cables from the projector.

### Cleaning the outer surface of the projector

Wipe off dirt and dust gently with a soft cloth.

- If it is difficult to remove the dirt, soak a cloth in water, wring the cloth well and then wipe the projector. Dry off the projector with dry cloth.
- Do not use petroleum benzine, thinner, any alcoholic solvent, kitchen detergents or chemical clothes. Failure to observe these may result in altered or damaged surface of the projector.

### Cleaning the lens surface

Wipe off dirt and dust gently with a lint-free cloth.

- Make sure no dirt or dust remains on the surface of the lens. It will be enlarged and projected onto the screen.

### Cleaning the air filter

If the air filter is excessively dirty, the internal temperature of the projector increases and may cause malfunction. Clean the air filter regularly every 100 hours of usage.

1. Place a finger at the bottom of the air filter.
2. Slightly push up and pull out the air filter to remove.

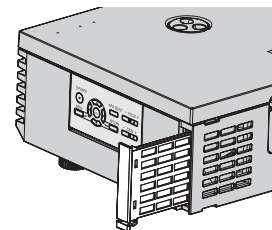

3. Vacuum dirt and dust from the air filter.
  - Do not wash the air filter.

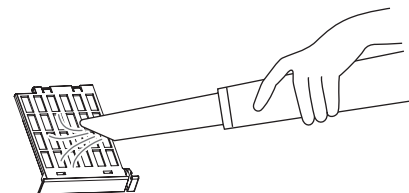

4. Place and slightly slide in the air filter in the air intake port to attach.
  - Make sure the air filter clicks into the place.

#### NOTE:

- Do not use the projector without attaching the air filter.

### Replacing the air filter

The air filter should be replaced when cleaning is ineffective and when replacing the lamp unit. A replacement air filter (TXFKN01VKF5) is provided with a replacement lamp unit, ET-LAE4000. Contact an Authorized Service Center for the optional air filter.

## Replacing the lamp unit

### Before replacing the lamp unit



- Switch off **MAIN POWER** in proper way and disconnect the power plug from the wall outlet.
- Wait for more than 1 hour and make sure the lamp unit and the surroundings are cooled enough.
- Unplug all the cables from the projector.
- Prepare a Phillips-head screwdriver.
- Contact an Authorized Service Center to purchase a replacement lamp unit (ET-LAE4000).
- When the projector is mounted on the ceiling, do not work directly under the projector or put your face closer to the projector.

#### NOTE:

- Prior to replacing the lamp unit, allow it to cool down to prevent the risk of burns, damage and other hazards.
- Do not attempt replacement with an unauthorized lamp unit.

### When to replace the lamp unit

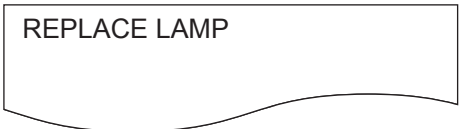
The lamp unit is consumable and the brightness decreases by duration of usage. The **LAMP** indicator will inform you of the replacement timing at 1 800 hours, and at 2 000 hours, the projector will be turned off. Those figures are rough guidance and might be shortened by the usage conditions, characteristics of the lamp unit, environmental conditions, and so on. You can check the duration of usage time using **LAMP RUNTIME** in the **OPTION** menu.

Indication	On screen	LAMP indicator
		
Over 1 800 hours	“REPLACE LAMP” is displayed on the upper left of the screen for 30 seconds. To clear the screen immediately, press any button.	Illuminates red.
Over 2 000 hours	“REPLACE LAMP” is displayed on the upper left of the screen, and it will stay until you respond. To clear the screen, press any button.	

#### NOTE:

- The guide times, 1 800 and 2 000 hours, are rough estimates based on certain conditions and are not guaranteed time. The estimated condition is: **LAMP POWER** in **OPTION** menu set to **NORMAL**.
- To prolong the lamp life, set the **LAMP POWER** in **OPTION** menu to **ECO-MODE**. See “LAMP POWER” in “OPTION menu” of the functional instructions that is in the provided CD-ROM.
- For more information about the lamp unit, such as guaranteed time, see the instructions which is provided with the lamp unit.

### Opening the top cover

1. Hold at the back corner of the top cover and slightly push up to open.
2. Unhook the top cover safety hook from the projector.
3. Hold the top cover up and press both sides of hinge parts to remove.
  - When the projector is mounted on the ceiling, removing the hinge parts is not required.
4. Remove the top cover aside.

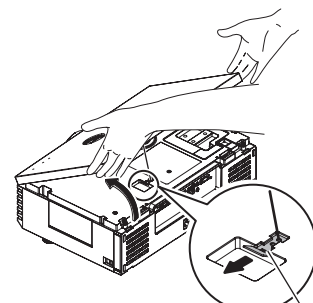

Top cover safety hook

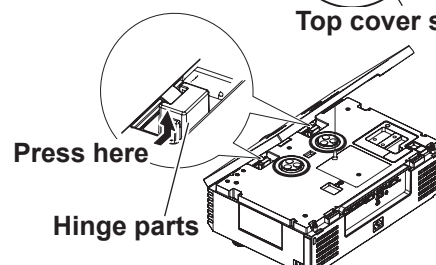

Hinge parts

#### NOTE: When the projector is mounted on the ceiling:

- Place yourself at the back side of the projector, then open and close the top cover.
- Do not work directly under the projector or put your face close to the projector.

## Care and Replacement

### Removing and replacing the lamp unit

1. Use a Phillips screwdriver to loosen the 3 lamp unit fixing screws until the screws turn freely.

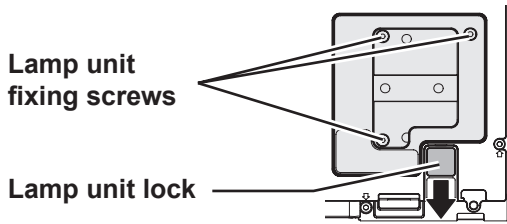

2. Hold the handle of the lamp unit and release the lamp unit lock in the direction of an arrow.
3. Pull out the lamp unit gently from the projector.

4. Replace the new lamp unit while making sure that the direction of insertion is correct.
  - Press the top of the lamp unit downwards and make sure the unit is installed securely.

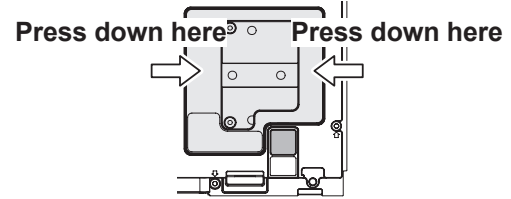

5. Tighten the lamp unit fixing screws securely with a Phillips screwdriver.

### Attaching the top cover

1. Attach the hinge parts of the top cover to the projector and press slightly until it clicks.
  - When the projector is mounted on the ceiling, attaching the hinge parts is not required.
2. Hook the top cover safety hook to the projector.
3. Hook the tabs of the top cover to the front of the projector body and lower slowly.
4. Press the back corner of the top cover gently until it clicks.
  - Make sure to hook the top cover safety hook to the body.

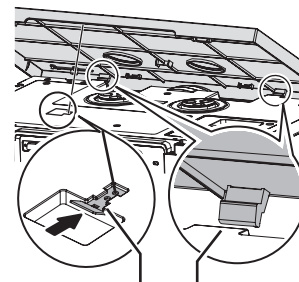

Top cover safety hook    Tabs

#### NOTE:

- Be sure to install the lamp unit and the top cover of the projector securely. If they are not securely installed, it may cause the protection circuit to operate so that the power cannot be turned on.
- Grip the handle and keep the lamp unit paralleled when you remove the lamp unit.
- Do not switch the power on while the top cover is opened.
- When the projector is mounted on the ceiling, keep the lamp unit paralleled up and remove.

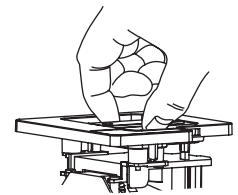

### Resetting the LAMP RUNTIME

If the lamp usage time has passed 2 000 hours (when **LAMP POWER** has been set to **NORMAL**), the projector will switch to standby mode after approximately 10 minutes of operation. The resetting procedure should thus be completed within 10 minutes.

1. Connect the power cord to the projector and a wall outlet, and switch **MAIN POWER** on.
2. Switch the power button.
3. Press the **MENU** button to display the menu.
4. Press **▲ ▼** to select **OPTION** and press the **ENTER** button.
5. Press **▲ ▼** to select **LAMP RUNTIME**.
6. Press and hold the **ENTER** button for approximately 3 seconds.
7. The confirmation screen will be displayed and select **OK**.
8. Switch off the power button to reset the duration of the **LAMP RUNTIME**.
9. Confirm the duration of time in **LAMP RUNTIME** is reset to "0".

HIGH ALTITUDE MODE	
LAMP POWER	NORMAL
VIERA LINK SETTINGS	
TEST PATTERN	
LAMP RUNTIME	1820H

# Troubleshooting

Should any problem persist, contact your dealer.

Problem	Cause	Reference page
<b>Power does not turn on.</b>	● The power cord may not be connected.	16
	● <b>MAIN POWER</b> is turned off.	17
	● No electric supply is at the wall outlet.	16
	● <b>TEMP</b> indicator is lit or flashes.	25
	● <b>LAMP</b> indicator is lit or flashes.	25
	● The lamp unit has not been securely installed.	27
	● The circuit breakers have tripped.	-
<b>No picture appears.</b>	● The signal input source may not be connected to a terminal properly.	15
	● The input selection setting may not be correct.	18
	● The <b>BRIGHTNESS</b> adjustment setting may be at the minimum setting.	CD-ROM
	● The <b>BLANK</b> function may be in use.	CD-ROM
<b>The picture is fuzzy.</b>	● The lens cover may still be attached to the lens.	12
	● The lens focus may not have been set correctly.	18
	● The projector may not be at the correct distance from the screen.	14
	● The lens may be dirty.	26
<b>The color is pale or grayish.</b>	● The projector may be tilted too much.	15
	● <b>COLOR</b> or <b>TINT</b> adjustment may be incorrect.	CD-ROM
	● The equipment which is connected to the projector may not be adjusted correctly.	-
<b>The Remote control does not operate.</b>	● The batteries may be weak.	-
	● The batteries may not have been inserted correctly.	11
	● The remote control signal receptor on the projector may be obstructed.	CD-ROM
	● The remote control unit may be out of the operation range.	CD-ROM
<b>The picture does not display correctly.</b>	● The signal format may not have been set correctly.	CD-ROM
	● There may be a problem with the VCR or other signal source.	-
	● A signal which is not compatible with the projector is being input.	31
<b>Picture from a computer does not appear.</b>	● The cable may be longer than the optional cable.	-
	● The external video output from a personal computer may not be correct. (You may be able to change the external output settings by pressing the [Fn] + [F3] or [Fn] + [F10] keys simultaneously. The actual method varies depending on the type of computer; refer to the documentation provided with your computer for further details.)	-

# Technical Information

## Ceiling mount bracket safeguards

The projector and the ceiling mount bracket are designed for sufficient safety. However, make sure the safety cable provided with the projector is installed and attached to the bottom of the projector when mounting on the ceiling for safety and security.

- Make sure to use a torque driver and do not use an electrical screwdriver or an impact screwdriver.

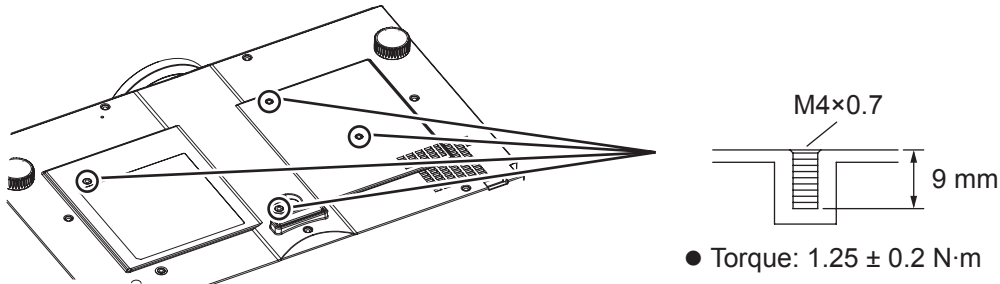

### NOTE:

- Even if it is during guaranteed period, the manufacturer is not responsible for any hazard or damage caused by using a ceiling mount bracket which is not purchased from an authorized distributors, or environmental conditions.
- Installation work of the ceiling mount bracket should only be carried by a qualified technician.
- Remove an unused ceiling mount bracket promptly.

### Installing the safety cable

1. Install the ceiling mount bracket according to the Installation Instructions.
2. Loop the safety cable around the ceiling mount bracket with less slack.
  - Lace the cable of the end with a latch through the loop on the other end of the cable.

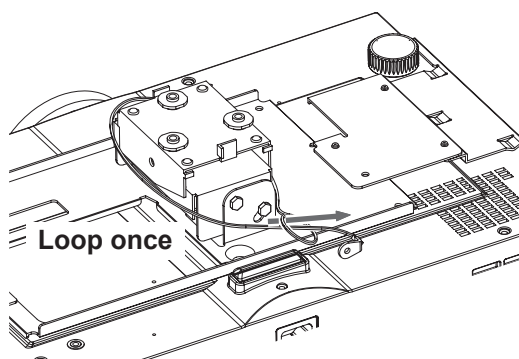

\* Indicated above is ET-PKE1000S.

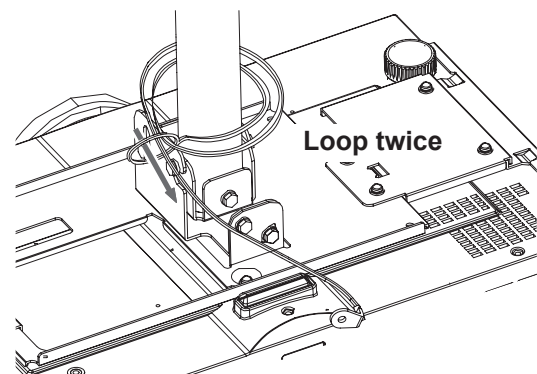

\* Indicated above is ET-PKE2000.

3. Attach the latch on to the bottom of the projector with a provided screw.

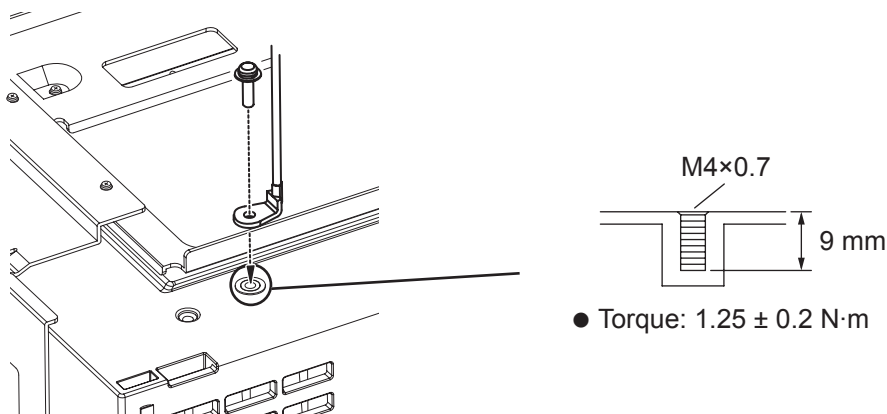

## List of compatible signals

Mode	Display	Display resolution (dots) <sup>*1</sup>	Scanning frequency		Dot clock frequency (MHz)	Picture quality <sup>*2</sup>	Format
			H (kHz)	V (Hz)			
NTSC/NTSC 4.43/ PAL-M/PAL60	-	720 × 480i	15.7	59.9	-	A	VIDEO/S-VIDEO
PAL/PAL-N/SECAM	-	720 × 576i	15.6	50.0	-	A	
525i (480i)	480i	720 × 480i	15.7	59.9	13.5	A	RGB/YP <sub>B</sub> Pr
625i (576i)	576i	720 × 576i	15.6	50.0	13.5	A	
525p (480p)	480p	720 × 483	31.5	59.9	27.0	A	RGB/YP <sub>B</sub> Pr/HDMI
625p (576p)	576p	720 × 576	31.3	50.0	27.0	A	
1 125 (1 080)/60i	1 080/60i	1 920 × 1 080i	33.8	60.0	74.3	AA	
1 125 (1 080)/50i	1 080/50i	1 920 × 1 080i	28.1	50.0	74.3	AA	
1 125 (1 080)/24p	1 080/24p	1 920 × 1 080	27.0	24.0	74.3	AA	
1 125 (1 080)/60p	1 080/60p	1 920 × 1 080	67.5	60.0	148.5	AA	
1 125 (1 080)/50p	1 080/50p	1 920 × 1 080	56.3	50.0	148.5	AA	
750 (720)/60p	720/60p	1 280 × 720	45.0	60.0	74.3	AA	
750 (720)/50p	720/50p	1 280 × 720	37.5	50.0	74.3	AA	
VGA480	VGA60	640 × 480	31.5	59.9	25.2	A	
	VGA75	640 × 480	37.5	75.0	31.5	A	
	VGA85	640 × 480	43.3	85.0	36.0	A	
	VGA138	640 × 480	72.1	138.0	62.3	A	
SVGA	SVGA55	800 × 600	35.2	56.3	36.0	A	
	SVGA60	800 × 600	37.9	60.3	40.0	A	
	SVGA70	800 × 600	48.1	72.2	50.0	A	
	SVGA75	800 × 600	46.9	75.0	49.5	A	
	SVGA85	800 × 600	53.7	85.1	56.3	A	
WIDE720	WIDE720	1 280 × 720	45.1	60.1	76.5	AA	
XGA	XGA60	1 024 × 768	48.4	60.0	65.0	A	
	XGA70	1 024 × 768	56.5	70.1	75.0	A	
	XGA75	1 024 × 768	60.0	75.0	78.8	A	
	XGA85	1 024 × 768	68.7	85.0	94.5	A	
	XGA89	1 024 × 768	72.1	89.0	99.2	A	
WIDE768	WIDE768	1 280 × 768	45.3	56.5	76.2	A	
MXGA	MXGA70	1 152 × 864	64.0	71.2	94.2	A	
	MXGA75	1 152 × 864	67.5	74.9	108.0	A	
SXGA	SXGA60	1 280 × 1 024	64.0	60.0	108.0	A	
SXGA60+	SXGA60+	1 400 × 1 050	65.1	59.9	122.4	A	
WIDE768-2	WIDE768-2	1 360 × 768	48.8	59.8	74.3	A	
WIDE800	WIDE800	1 280 × 800	49.7	59.8	83.5	A	
WIDE900	WIDE900	1 440 × 900	55.9	59.8	106.5	A	
WIDE1080/60	WIDE1080/60	1 920 × 1 080	66.5	59.9	138.5	AA	
WIDE1080/50	WIDE1080/50	1 920 × 1 080	55.6	49.9	141.5	AA	

\*1. The "i" appearing after the resolution indicates an interlaced signal.

\*2. The following symbols are used to indicate picture quality.

AA Maximum picture quality can be obtained.

A Signals are converted by the image processing circuit before picture is projected.

## Specifications

<b>Power supply</b>		AC 100 - 240 V 50 Hz/60 Hz
<b>Power consumption</b>		Less than 240 W During standby (when fan is stopped): 0.08 W (at 220 V)
<b>Amps</b>		3.0 A - 1.5 A
<b>LCD panel</b>	<b>Panel size (diagonal)</b>	0.74 type (17.78 mm)
	<b>Aspect ratio</b>	16:9
	<b>Display method</b>	3 transparent LCD panels (RGB)
	<b>Drive method</b>	Active matrix method
	<b>Pixels</b>	2 073 600 (1 920 × 1 080) × 3 panels
<b>Lens</b>		Motorized zoom (2 ×)/Motorized focus F 1.9 - 3.2, f 22.4 mm - 44.8 mm
<b>Lamp</b>		UHM lamp (170 W)
<b>Luminosity**1</b>		1 600 lm
<b>Operating environment</b>		Temperature 0 °C - 40 °C (32 °F - 104 °F) When the HIGH ALTITUDE MODE (See the functional instructions that is in the provided CD-ROM.) is set to ON: 0 °C - 35 °C (32 °F - 95 °F)
		Humidity 20 % - 80 % (no condensation)
<b>Scanning frequency**2 (for RGB signal)</b>	<b>Horizontal scanning frequency</b>	30 kHz - 70 kHz
	<b>Vertical scanning frequency</b>	50 Hz - 87 Hz
	<b>Dot clock frequency</b>	Less than 150 MHz
<b>COMPONENT (YP<sub>B</sub>Pr) signals</b>		525i (480i), 525p (480p), 625i (576i), 625p (576p), 750 (720)/60p, 750 (720)/50p, 1 125 (1 080)/60i, 1 125 (1 080)/50i, 1 125 (1 080)/60p, 1 125 (1 080)/50p, 1 125 (1 080)/24p
<b>Color system</b>		7 (NTSC/NTSC 4.43/PAL/PAL-M/PAL-N/PAL60/SECAM)
<b>Projection size</b>		40" - 300" (1 016 mm - 7 620 mm)
<b>Throw distance</b>		1.2 m - 18 m (3'11" - 59')
<b>Installation</b>		FRONT/DESK, FRONT/CEILING, REAR/DESK, REAR/CEILING (Menu selection method)

\*1. Measurement, measuring conditions and method of notation all comply with ISO 21118 international standards.

\*2. See "List of compatible signals" on page 31 for available signals.



<b>Terminals</b>	<b>S-VIDEO IN</b>	Single-line, Mini DIN 4p Y: 1.0 V [p-p], C: 0.286 V [p-p], 75 Ω
	<b>VIDEO IN</b>	Single-line, RCA pin jack 1.0 V [p-p], 75 Ω
	<b>COMPUTER IN</b>	Single-line, D-sub HD 15-pin (female)
		R.G.B. 0.7 V [p-p], 75 Ω
		G.SYNC 1.0 V [p-p], 75 Ω
		HD/SYNC TTL high impedance, automatic positive/negative polarity compatible
	VD TTL high impedance, automatic positive/negative polarity compatible	
<b>COMPONENT IN</b>	Y, P <sub>B</sub> /C <sub>B</sub> , P <sub>R</sub> /C <sub>R</sub> Single-line, RCA pin jack × 3	
	Y: 1.0 V [p-p] (including sync), 75 Ω	
	P <sub>B</sub> /C <sub>B</sub> , P <sub>R</sub> /C <sub>R</sub> 0.7 V [p-p], 75 Ω	
<b>HDMI IN</b>	Triple-line, 19-pin HDMI connector HDMI™ (Deep Color, x.v.Color™), HDCP/HDAVI Control Ver. 4 compliant	
<b>SERIAL</b>	D-sub 9-pin RS-232C compatible	
<b>TRIGGER</b>	Dual-line monaural mini jack DC 12 V, max.100 mA (Selectable for input and output by menu operation.)	
<b>Cabinet</b>	Moulded plastic (PC+ABS)	
<b>Dimensions</b>	Width 460 mm (18 1/8")	
	Height 130 mm (5 1/8")	
	Length 300 mm (11 3/4")	
	(excluding protruding parts)	
<b>Weight</b>	Approx. 7.3 kg (16.09 lbs.)* <sup>1</sup>	
<b>Certifications</b>	UL60950-1 C-UL	
	FCC Class B ICES-003	
<b>Remote control</b>	<b>Power supply</b>	3 V DC (AA battery × 2)
	<b>Operating range</b>	Approx. 7 m (22'11") (when operated directly in front of signal receptor)
	<b>Weight</b>	125 g (4.4 ozs.) (including batteries)
	<b>Dimensions</b>	Width 48 mm (1 7/8")
Length 138 mm (5 3/8")		
Height 28.35 mm (1 1/8") (excluding protruding parts)		
<b>Options</b>	<b>Cable cover</b>	ET-PCE2000
	<b>Ceiling bracket</b>	ET-PKE2000/ET-PKE1000S

\*1. Average value. Each product has an individual variability in weight.

## Technical Information

## Trademark acknowledgements

- HDAVI Control™ and VIERA Link™ are trademarks.
- VGA and XGA are trademarks of International Business Machines Corporation.
- S-VGA is a registered trademark of the Video Electronics Standards Association.
- HDMI, the HDMI logo and High-Definition Multimedia Interface are trademarks or registered trademarks of HDMI Licensing LLC.
- The font used in the on-screen displays is a Ricoh bitmap font, which is manufactured and sold by Ricoh Company, Ltd.

All other trademarks are the property of the various trademark owners.

## Dimensions

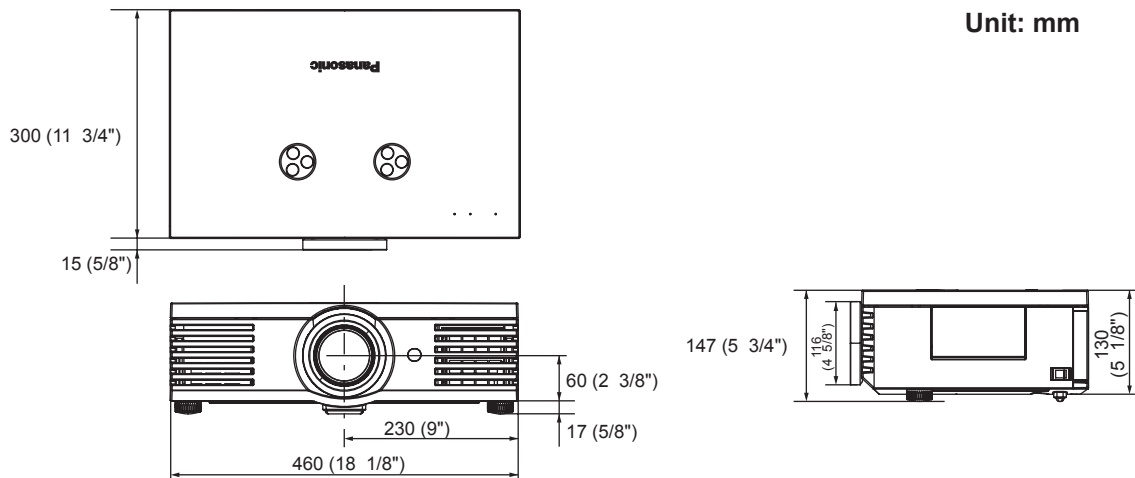

# Index

- A**
  - Accessories ..... 10
  - AC IN ..... 13
  - Air exhaust port ..... 12
  - Air filter ..... 12
    - Replacing ..... 26
  - Air intake port ..... 13
- B**
  - Batteries
    - Accessory ..... 10
    - Compartment ..... 11
- C**
  - CD-ROM
    - Accessories ..... 10
    - Menu ..... 19
  - Ceiling mount bracket ..... 30
  - Cleaning ..... 26
  - COMPONENT IN
    - Terminal ..... 13
  - COMPUTER IN
    - Terminal ..... 13
  - Connections ..... 15
  - CONTROL PANEL ..... 12
- D**
  - DEFAULT
    - Remote control button ..... 11
    - Remote control function ..... 19
  - Dimensions ..... 34
- E**
  - ENTER
    - Control panel button ..... 12
    - Remote control button ..... 11
- F**
  - FOCUS
    - Control panel button ..... 12
  - FREEZE
    - Remote control button ..... 11
  - Front leg adjusters ..... 13
  - FUNCTION
    - Remote control button ..... 11
  - FUNCTION BUTTON
    - Remote control buttons ..... 11
- H**
  - HDMI IN
    - Terminal ..... 13
  - HOME THEATER MUTE ..... 24
  - HOME THEATER VOLUME ..... 24
- I**
  - INPUT SELECT
    - Control panel button ..... 12
    - Remote control button ..... 11
  - INSTALLATION
    - Projection method ..... 14
- L**
  - LAMP
    - Indicator status ..... 25
    - LAMP Indicator ..... 12
  - LAMP RUNTIME ..... 28
  - Lamp unit
    - Replacing ..... 27
  - LENS
    - Remote control button ..... 11
  - LENS CONTROL
    - Remote control button ..... 11
  - Lens cover ..... 12
    - Accessory ..... 10
    - Attachment hole ..... 13
  - Lens shift
    - Lens shift dial • Horizontal ..... 12
    - Lens shift dial • Vertical ..... 12
- M**
  - MAIN POWER ..... 12
  - MEMORY LOAD
    - Remote control button ..... 11
  - Menu
    - Menu list ..... 20
    - Navigation ..... 19
  - MENU
    - Control panel button ..... 12
    - Remote control button ..... 11
    - Remote control function ..... 19
- N**
  - Navigation buttons
    - Control panel button ..... 12
    - Remote control button ..... 11
- O**
  - OPERATE OTHER DEVICE ..... 24
- P**
  - PICTURE ADJUSTMENT
    - Remote control button ..... 11
  - PICTURE MODE
    - Remote control button ..... 11
  - Power
    - Control panel button ..... 12
    - Indicator ..... 12
    - Indicator status ..... 16
    - Remote control button ..... 11
  - Power cord ..... 12
    - Accessory ..... 10
    - Connecting ..... 16
  - Power cord secure lock ..... 10, 16
  - Projection lens ..... 12
- R**
  - Remote control ..... 11
    - Accessory ..... 10
    - Signal emitter ..... 11
    - Signal receptor ..... 12
  - RETURN
    - Control panel button ..... 12
    - Remote control button ..... 11
    - Remote control function ..... 19
- S**
  - Safety cable ..... 30
    - Accessory ..... 10
    - Attachment point ..... 13
  - Screen size ..... 14
  - Calculation methods ..... 14
  - Security lock ..... 13
  - SERIAL
    - Terminal ..... 13
  - Specifications ..... 32
  - S-VIDEO IN
    - Terminal ..... 13
- T**
  - Technical Information ..... 30
  - TEMP
    - Indicator ..... 12
    - Indicator status ..... 25
  - Throw distance ..... 14
  - Top cover ..... 13, 27
  - TRIGGER
    - Terminal ..... 13
  - Troubleshooting ..... 29
- V**
  - VIDEO IN
    - Terminal ..... 13
  - VIERA Link ..... 23
    - Remote control button ..... 11
  - VIERA LINK CONTROL ..... 23
- W**
  - WAVEFORM MONITOR
    - Remote control button ..... 11
- Z**
  - ZOOM
    - Control panel button ..... 12

---

# Panasonic Corporation

Web Site : <http://panasonic.net/avc/projector/>

© Panasonic Corporation 2009

---

## **Panasonic Broadcast & Television Systems Company** **Unit of Panasonic Corporation of North America**

One Panasonic Way, Secaucus, NJ 07094

TEL: (201) 348 - 7000

### **Technical Support:**

TEL: (888) 411 - 1996

FAX: (201) 348 - 7523

E-Mail: [projectorsupport@us.panasonic.com](mailto:projectorsupport@us.panasonic.com)

### **Panasonic Canada Inc.**

5770 Ambler Drive, Mississauga, Ontario L4W 2T3

TEL: (905) 624 - 5010

P1009-1109B  
TQBJ0309